

# MACP501 series

**AIR UNIT (F.R.L.UNIT)**



Option: **MP41**

### Symbol

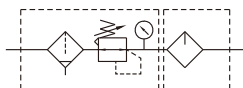

### Specification

Model	MACP501	
Components	MAFR501, MAL501	
Bore No.	20A	25A
Port size	3/4	1
Medium	Air	
Operating pressure range (*)	0.05~1 MPa	
Proof pressure	1.5 MPa	
Regulated pressure range	0.05~0.85 MPa	
Ambient temperature	- 5~+60°C (No freezing)	
Filter element	40μm	
Lubricating oil capacity	200c.c	
Min. flow for oil drip	25 ℓ/min	33 ℓ/min
Recommended lubricating oil	Turbine oil ISO-VG32	
Attachment	Pressure gauge (PG-20), bracket	
Weight	Nylon bowl, PC bowl: 3480 g	
	Metal bowl: 3720 g	

\* Standard unit contains semi-auto-drain function when operating pressure below 0.05 MPa.

\* Choose auto-drain FMRF300, the pressure range is 0.15~1 MPa.

### Order example

**MACP501 - 20A - MC□ - E1 - T8 - □**

MODEL

PORT SIZE

20A: 3/4  
25A: 1

(Option)  
PRESSURE  
SWITCH

E1: MP41P-022  
E2: MP41P-022-QD  
E5: MP41P-042  
E6: MP41P-042-QD

(Option)  
Module  
mounting bracket

T8: 1/4  
T10: 3/8  
T15: 1/2

PORT THREAD

Blank: Rc thread  
G: G thread  
NPT: NPT thread

(Option) ACCESSORIES

\* Refer to page 5-12 for MP41.

Bowl	Pressure gauge	Drain valve
Blank: PC bowl M: Metal bowl N: Nylon bowl	Blank: Pressure gauge (PG-20) C: External pressure gauge (PG-40) + Gauge adapter set (A-MAR302) A: Gauge adapter set (A-MAR302)	Blank: Semi-auto drain D: Auto drain valve (FMRF300)

\* PG-40 (C) and MP41 (E\*) can not be selected at the same time.

### Flow feature

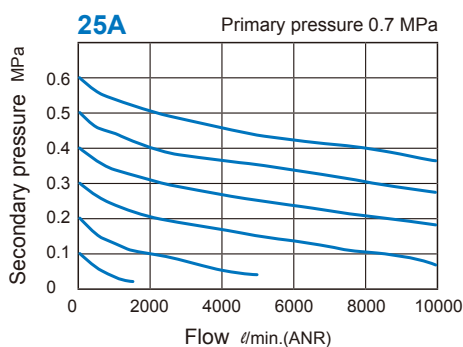
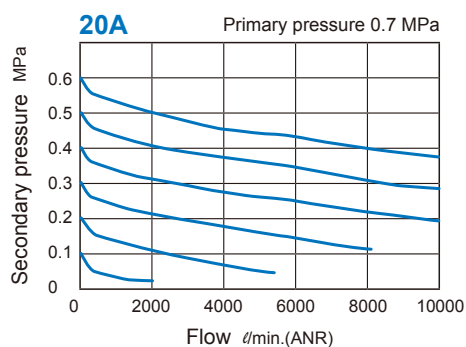

# MACP501 Dimensions

AIR UNIT (F.R.L.UNIT)



## Accessories

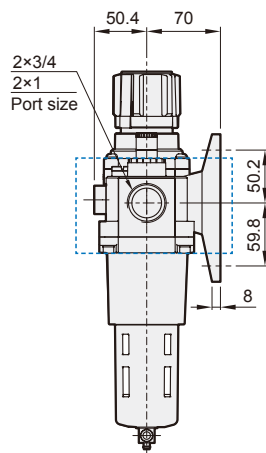
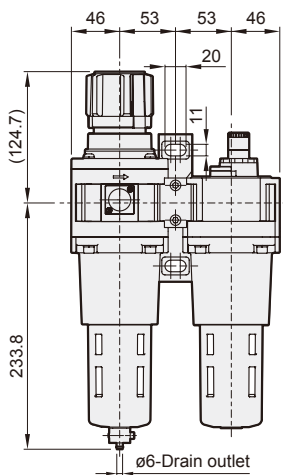
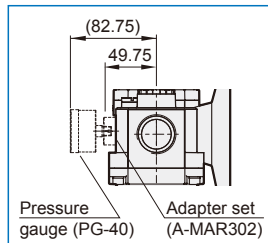
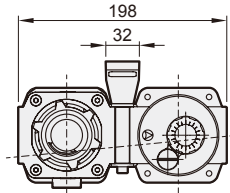

## MACP501-M

Metal bowl

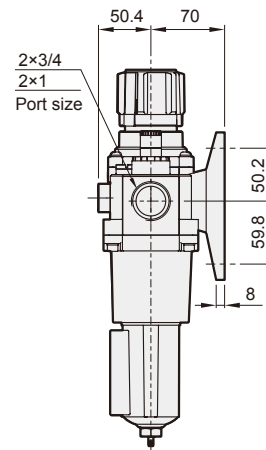
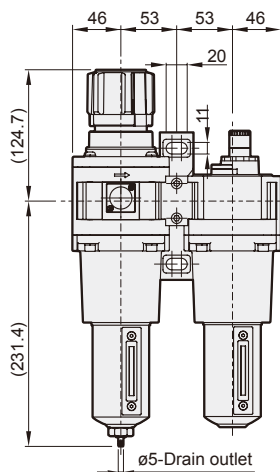
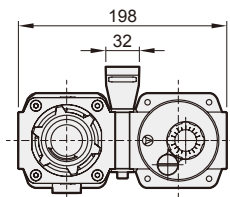

## MACP501-D

Auto drain valve

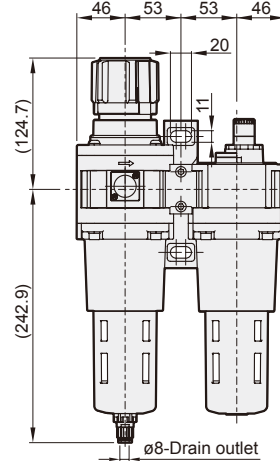

## MACP501-T\*

T type bracket

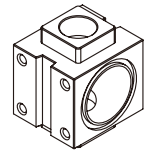
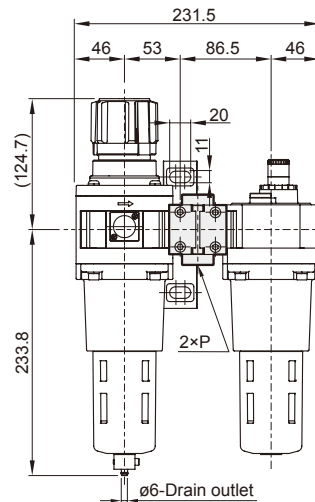

Port Bracket	P
T8	1/4
T10	3/8
T15	1/2

## MACP501-MD

Metal bowl + auto drain valve

